



BACKYARD
SNOWSTORM



Forecaster
3-4

Instruction Manual

v6.0

Congratulations on purchasing a Backyard Snowstorm Forecaster Snow Gun! We're excited for you to make snow with us!

Please check out our full instructional course below for in-depth instructional videos regarding the Forecaster Snowmaking System.

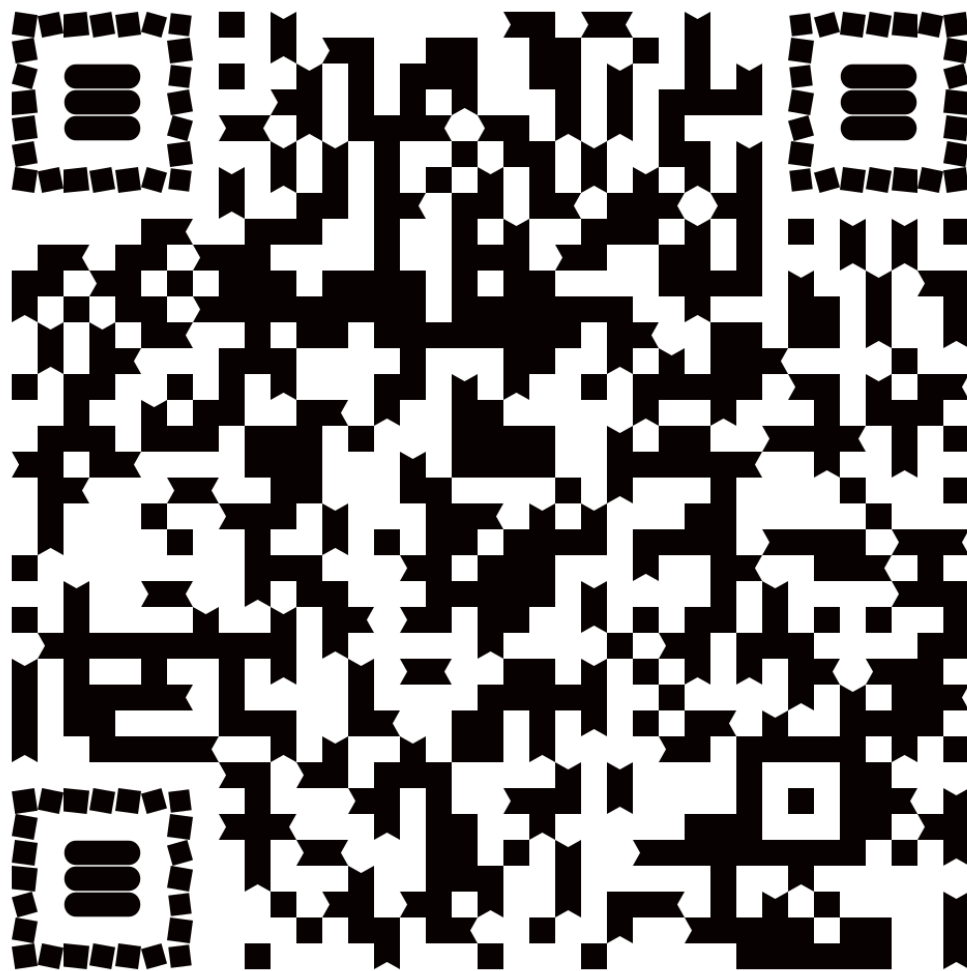



WARNING!!!

This is a high-pressure system. Failure to follow procedures and instructions could lead to injury and/or damage to equipment.

Safety Guidelines:

- **Always use protective clothing when setting up or taking down equipment.**
- **Follow safety guidelines listed with each pressure washer and air compressor.**
- **Make sure all connections are tight and secure.**
- **NEVER point a snow gun or hose near yourself or others.**
- **Use caution around snow gun surfaces. Surfaces near and around snow gun WILL become wet and slippery.**
- **Follow ALL setup and take down procedures exactly.**
- **Ensure snow gun stand is lowered and secured before turning on any equipment.**

Table of Contents

Parts and Equipment.....	5
STEP 1 - Prepare the Snow Gun Stand.....	6
STEP 2 - Select Proper Misting Nozzles.....	8
STEP 3 - System Setup.....	10
STEP 3A - Train System Setup.....	13
STEP 4 - System Start-up.....	15
STEP 5 - System Take-down.....	17
STEP 6 - Pressure Gauge Information.....	20
Troubleshooting Help.....	21
Snowmaking Weather Chart.....	25
Quick Guide	26

Parts and Equipment

(included with Forecaster or Train Systems or optional add-ons)



Snow Gun Body



Stand Attachment



Bolt Pack (2x each part)



Nozzle Pack (1-6 GPM)



Low Pressure Filter



Low/High Pressure Blow Out Tools



Pressure Gauge



Pressure Washer Quick Connection Adapter Pack (M22 Male & Female, 3/8" NPT Female)



Garden Leader Hose



Garden Hose Split Connection



High Pressure Manifold (double, triple or quad version)



High Pressure Hose

NOT INCLUDED:



Garden Hose



Air Compressor



Pressure Washer(s)

Step 1 – Prepare the Snow Gun Stand

1-1

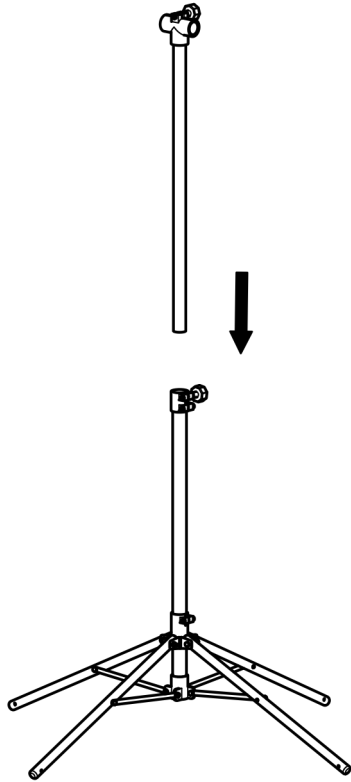

- Insert top stand into the tripod base

1-2

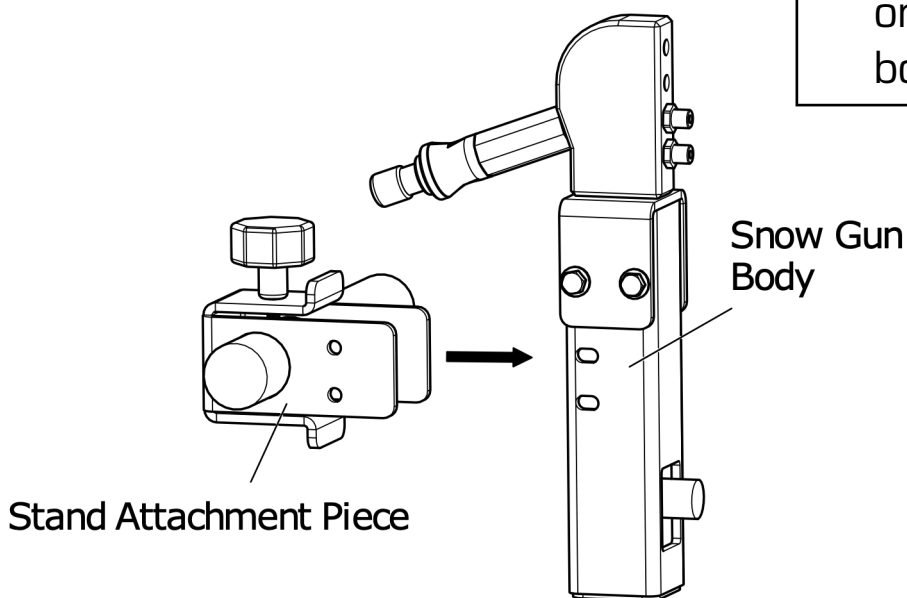

- Position the stand attachment piece onto the snow gun body

1-3

- Secure with provided 1/4" bolts, washers, and 1/4" lock nuts (Firmly Secure)

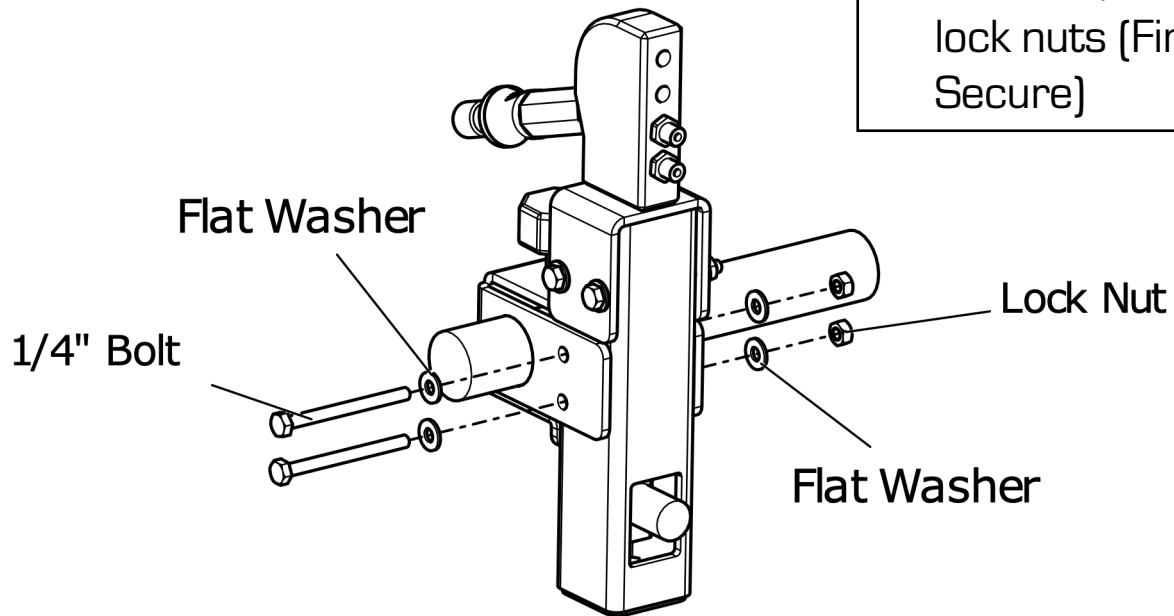

11 mm socket

1-4

- Secure the assembled snow gun into the top of the tripod stand. Lower the snow gun and tighten all blue twist bolts

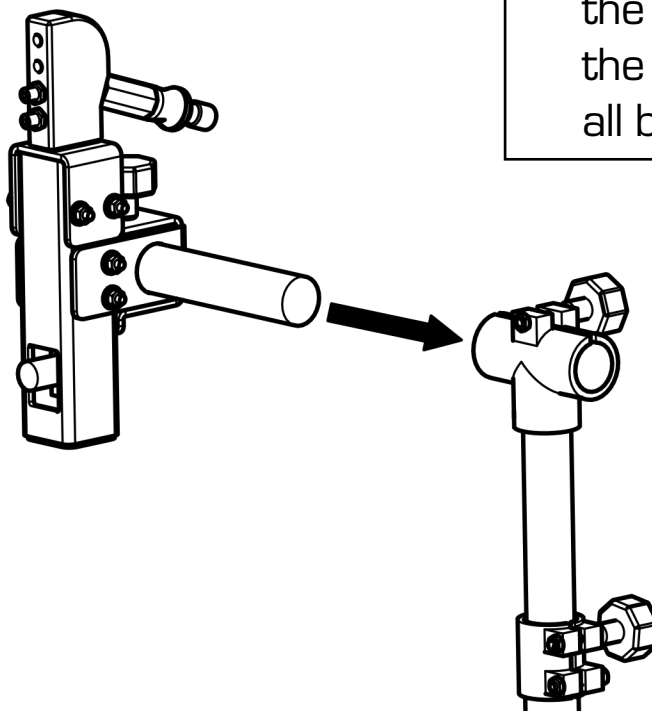

Step 2 – Select Proper Misting Nozzles

2-1

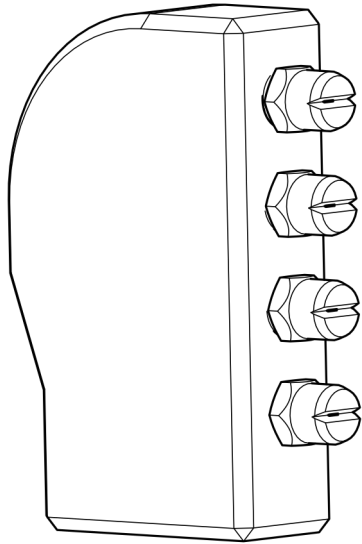

Proper misting nozzles **MUST** be used to create the correct misting water droplets for snow formation.

Each nozzle will have a number engraving on the top face

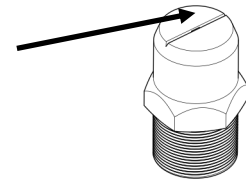

2-2

- Select the proper misting nozzles for your system according to the flow rate (GPM) of your pressure washer

Using Multiple Pressure Washers in a Train Setup? – Add the flow rate of each pressure washer to find the Total Flow Rate and select the proper nozzles

1.0 - 1.7 GPM

1.8 - 2.4 GPM

2.5 - 3.4 GPM

3.5 - 4.0 GPM

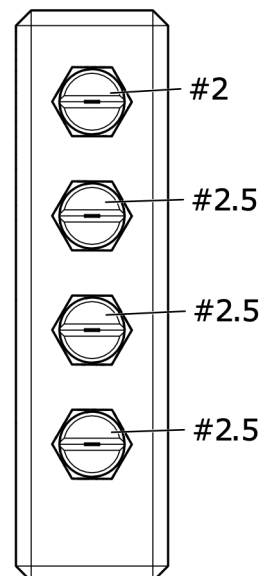
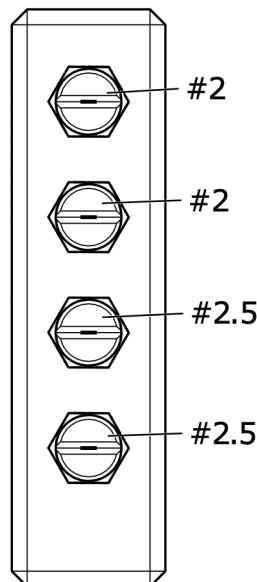
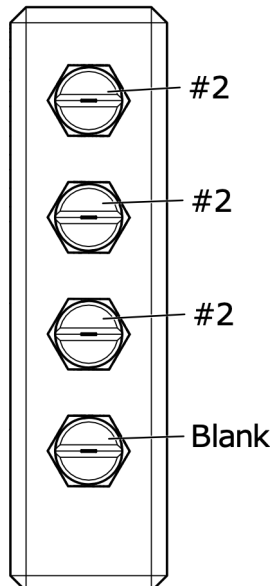
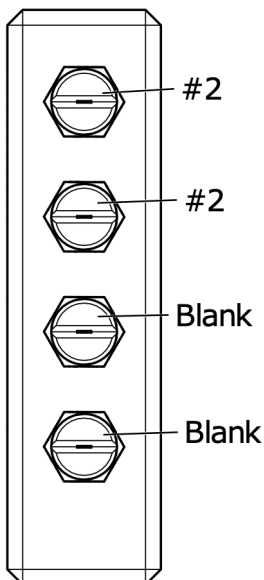

2-2 Continued

4.1 - 4.5 GPM

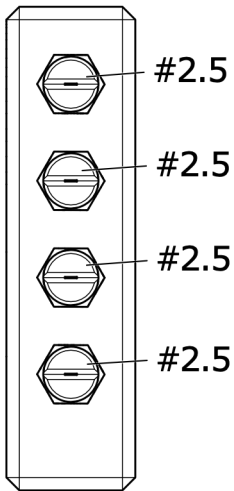

4.6 - 5.3 GPM

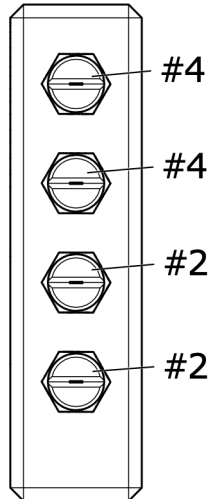

5.4 - 6.0 GPM

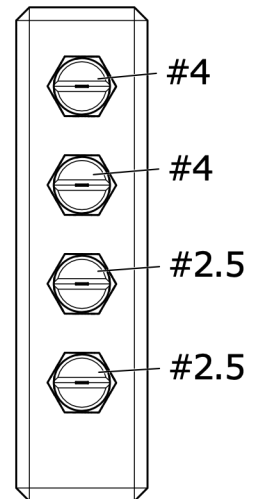

2-3

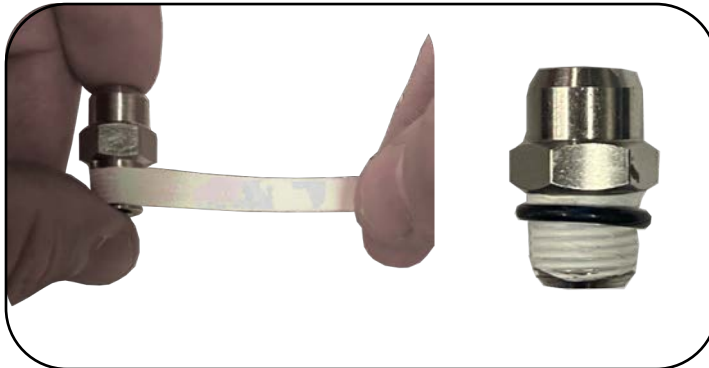

- Apply Teflon Tape and o-ring to the nozzles

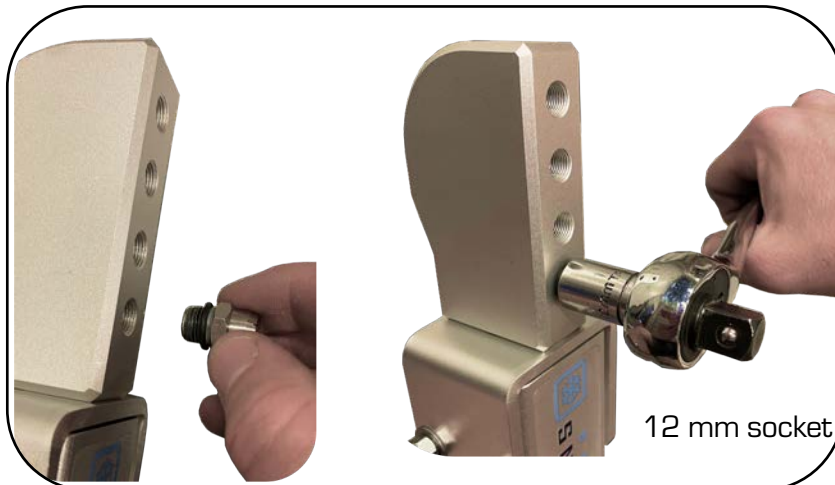

- Insert nozzles into head, and tighten firmly to avoid leaking



Caution! Do not cross thread nozzles

TIP: cut a 5" section of Teflon and cut it length wise down the middle. Use one strip to wrap one nozzle.

Step 3 – System Setup

Overview

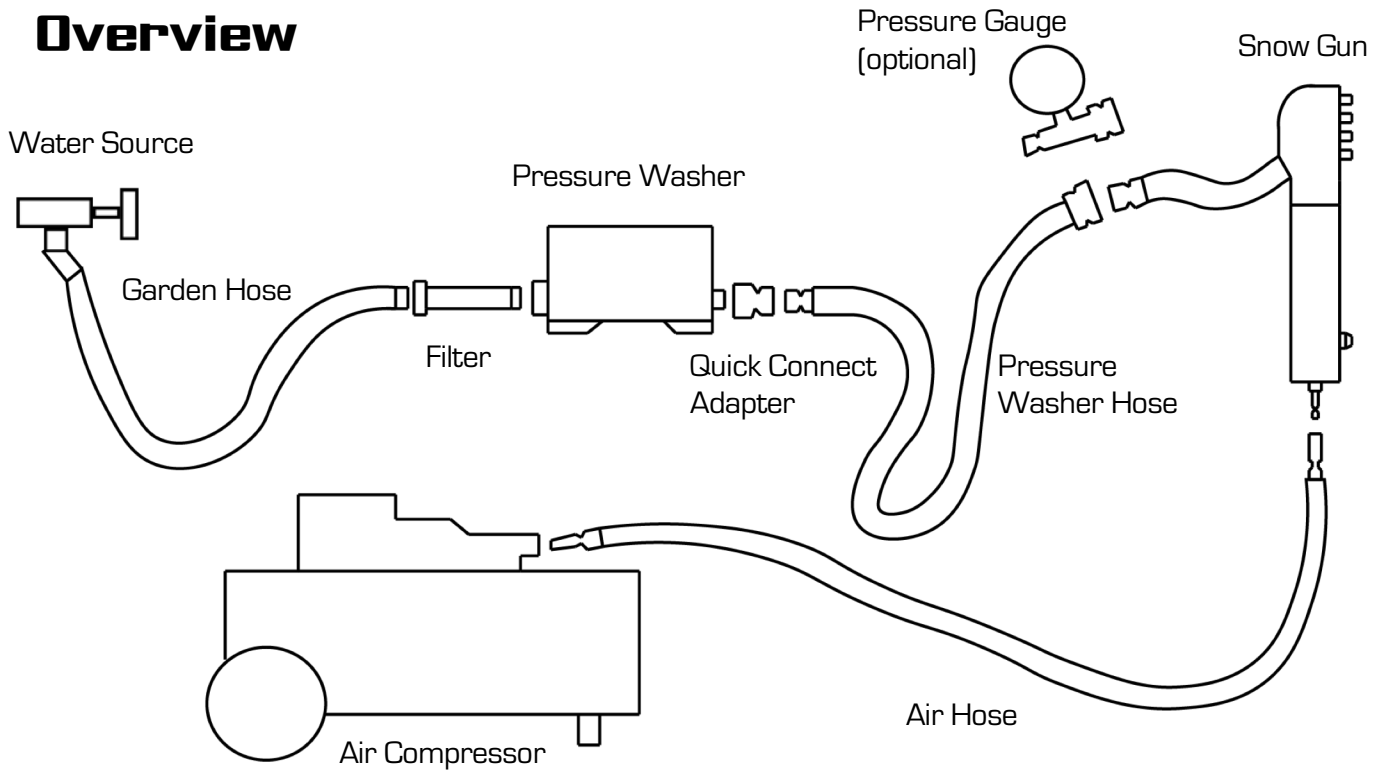

3-1



- Connect garden hose to water source

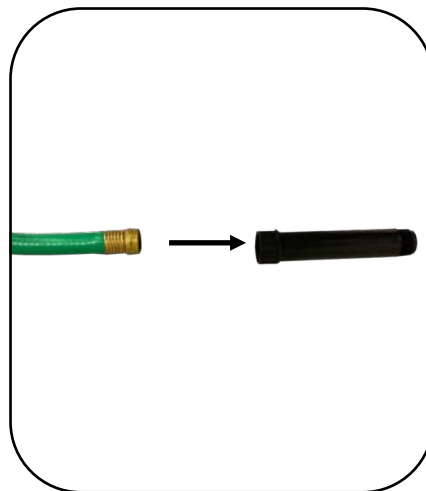

- Connect garden hose to low pressure filter



- Connect low pressure filter to pressure washer

3-2

Option 1 (recommended)



- Connect quick connection adapter fitting



- Connect pressure washer hose

Option 2



- Connect pressure washer hose directly

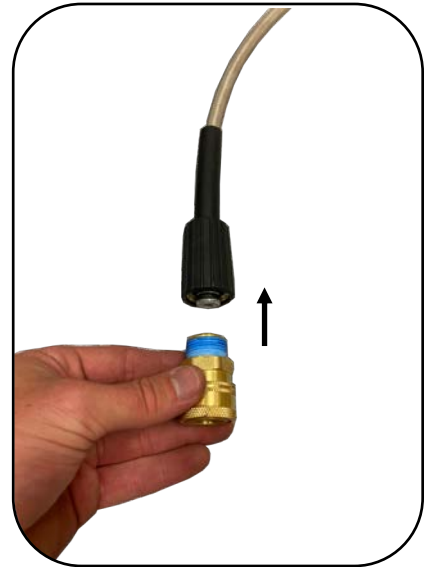

- Connect quick connection to hose end

Common pressure washers have an M22 or 3/8" NPT male thread connection on the pressure washer.

3-3



- Connect pressure washer hose to snow gun

(Optional)

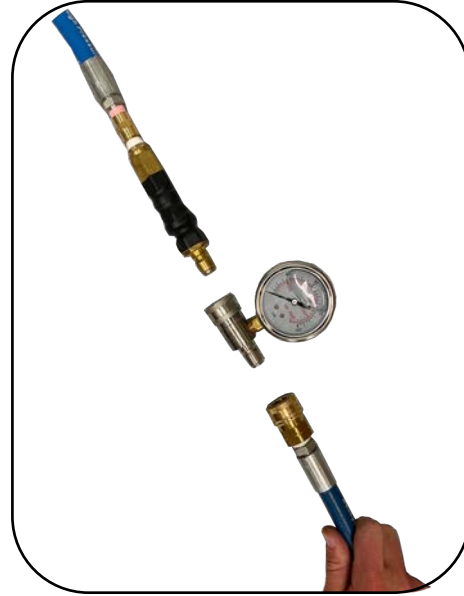

- Connect pressure gauge before the snow gun

3-4

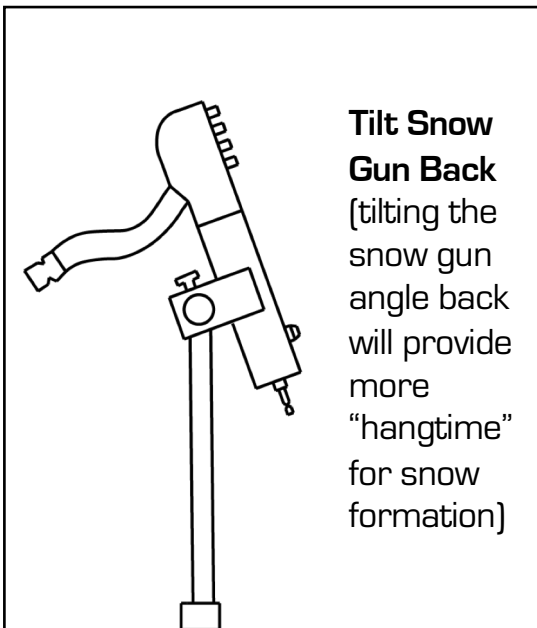

- Make sure all connections are tight! Use Teflon Tape to wrap any threads to create a tight seal.
- **Make sure snow gun stand is secured and lowered**

You are now ready to turn on your system! Continue to step 4...

Step 3A – Train System Setup

Overview

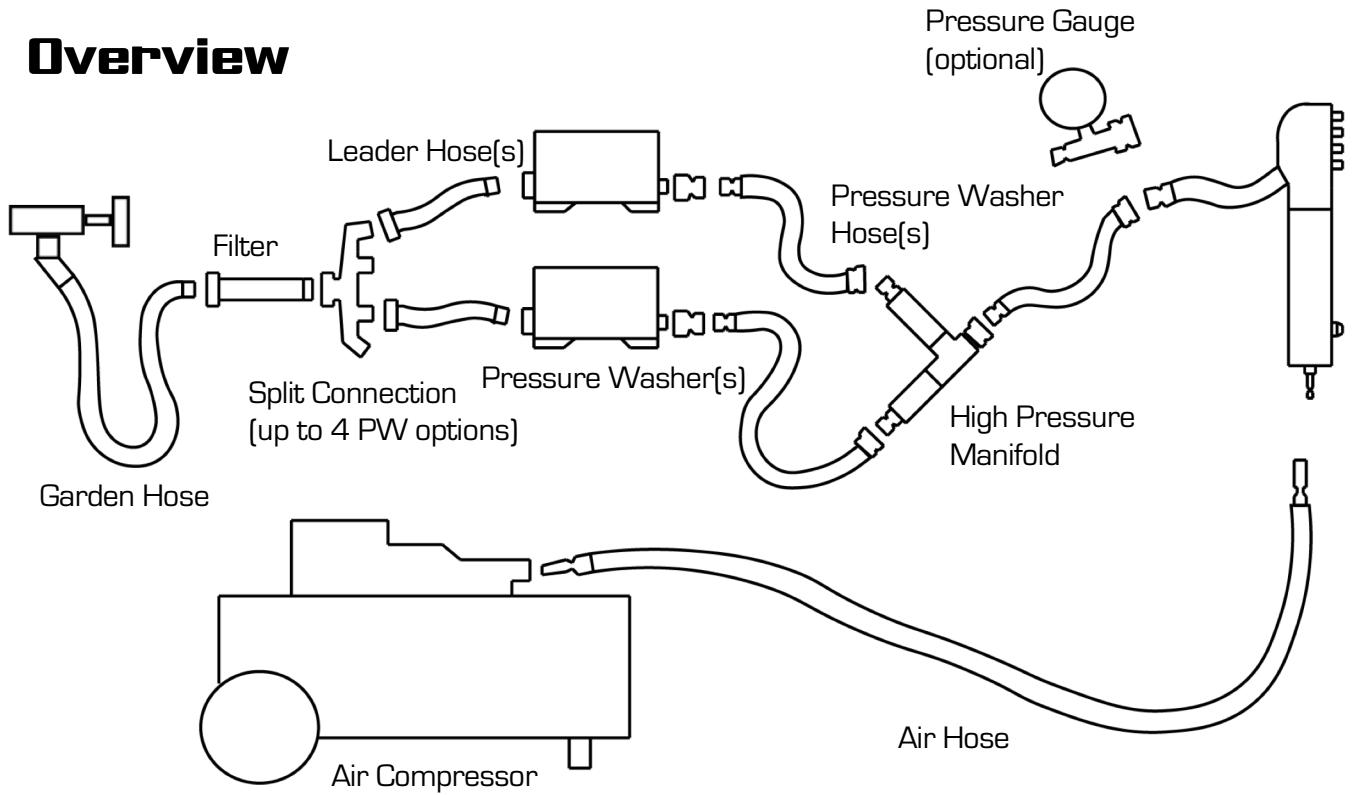

3A-1



- Connect garden hose to water source

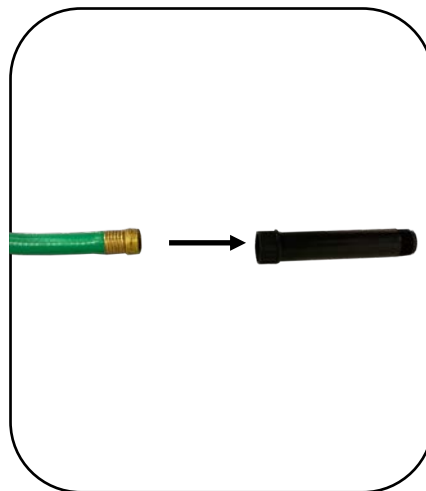

- Connect garden hose to low pressure filter



- Connect low pressure filter to split connection

3A-2



- Connect garden leader hoses to the split connection



- Connect garden leader hoses to each pressure washer inlet



- Make sure valves are in the OPEN position so water can flow to each pressure washer

3A-3

- Follow **Step 3-2** for each pressure washer

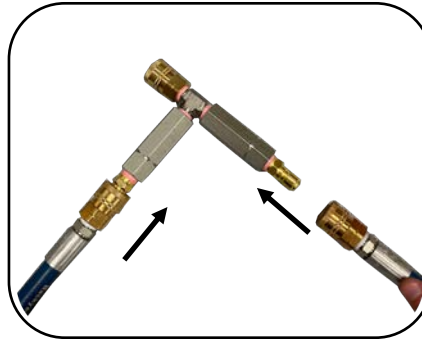

- Connect PW hoses from each PW to the HP Manifold

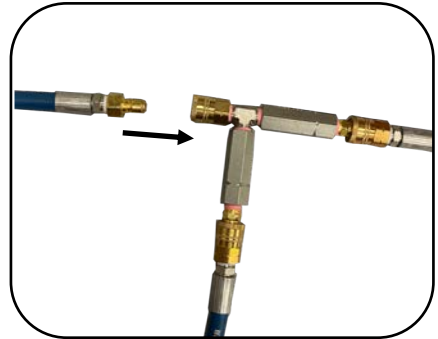

- Connect PW hose to the HP Manifold

- Follow **Step 3-3**, and **Step 3-4**

You are now ready to turn on your system! Continue to step 4...

Step 4 – System Start-Up

4-1



- Turn on the water

Make sure water flows through the entire water line and exits the snow gun. Water should exit the top misting nozzles (not blank nozzles), and a small stream should exit the bottom nucleation nozzle.

4-2

MAKE SURE SNOW GUN STAND IS SECURE BEFORE THIS STEP!



- Turn on the pressure washer
(you will see a significant increase in water exiting the nozzles)

- Train Systems: Turn on each pressure washer one by one

Train Systems: ensure all used valves on the garden hose split connection are OPEN and supplying water to each pressure washer being used.

4-3



- Connect air hose from compressor to snow gun
- Turn on air compressor and allow pressure to build

Pressure at the compressor should run between 75 - 125 PSI

*Do NOT regulate the compressor tank. Let it run at full capacity.

4-4

Setup
Quick Review

- Turn on Water
- Turn on Pressure Washer(s)
- Plug in/Turn on Air Compressor

DO NOT PLUG IN AIR BEFORE TURNING ON PRESSURE WASHERS!

The cold compressed air can quickly freeze the bottom nucleation nozzle and will require de-icing to blow snow.

Step 5 – System Take Down

5-1

Take Down Procedures are the REVERSE of the start-up procedures



- Unplug the air line from the snow gun

Do not drain the compressor. Compressed air is required to blow excess water out of the head.

5-2



- Turn OFF the pressure washer(s)



- Turn OFF the water at the water source



- Disconnect the garden hose

5-3



- Insert Blow Out Tool into female end of garden hose

USE CAUTION!!! Make sure snow gun and hoses are SECURE.

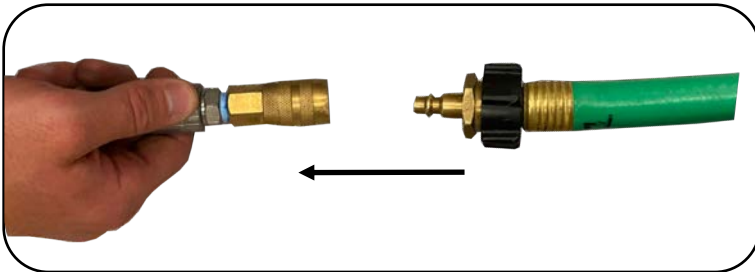

- Plug Blow Out Tool into air hose/compressor to blow out water

The compressed air will push water through the water line and out of the snow gun. Thoroughly blow out the water line (5-10min if necessary)

5-4 OPTIONAL (but recommended!)



- Separately blow out each section of the water line (With GH & HP Blow Out Tools)
- Blow Out Snow Gun (with HP Blow Out Tool)

FIRMLY SECURE HOSE END WHEN BLOWING OUT SEPARATE EQUIPMENT!!!

The goal is to remove all water from the system. This will ensure the functionality of your snow gun and will make future snow making sessions easy and hassle-free!

5-5



- Store Equipment in a dry, warm location

BEST PRACTICE: store your equipment in a large storage bin indoors or in an area that is above freezing temperatures. Even though no water should be left in the equipment after the blow out process, storing in a dry, warm location will extend the life of your equipment and make things easy when setting up your system next time you want to make snow.

5-6

Take Down Quick Review

- **Unplug Air Hose**
- **Turn OFF Pressure Washer(s)**
- **Turn OFF Water**
- **Blow out entire water line** (Each item separately is recommended)
- **Store Equipment for next time!**

Step 6 – Pressure Gauge Information

- 6-1** The Pressure Gauge is used to monitor the water pressure exiting the snow gun. Understanding the pressure will ensure the correct size of water droplets are formed in the snow gun.



- In cold temperatures*, the correct target pressure range is: **400 – 800 PSI**

IF YOUR PRESSURE IS UNDER 400 PSI:

Ensure the correct nozzles are installed and that the feed water and pressure washer are turned on. If the pressure washer is not turning on, you may need to push the “reset/test” button on the plug if it has one. **TRAIN SYSTEMS:** make sure the valves are open on the garden split connection and each pressure washer is turned on. If one of the pressure washers is not working, the pressure will be very low. Using a flow meter along with the pressure gauge can be helpful with Triple/Quad Setups.

IF YOUR PRESSURE IS OVER 800 PSI:

Ensure the top misting nozzles are not clogged. Check that the high-pressure filter is not dirty or restricted. Gently clean the brass high-pressure filter on the snow gun every 3 - 4 sessions.

Some pressure washers do not perform as they are marketed. For example, a pressure washer could be rated for 1.2 GPM but it actually outputs just 1 GPM.

*Our included pressure gauge will read higher if temperatures are warm

TROUBLESHOOTING HELP

MAKING ICE (or low-quality snow)

Restricted Air Flow: The bottom nucleation nozzle needs a high amount of air flow + air pressure to break up the water into smaller droplets used for nucleation. If this air flow is restricted, the ice crystals formed will be too large and nucleation will be difficult or impossible, resulting in ice. Here are some possible reasons you may have restricted air flow:

- **Undersized Compressor** (will not supply enough air flow/pressure needed for the nucleation nozzle)

SOLUTION: Make sure your air compressor meets the minimum output requirement of 5 CFM @ 90 PSI

- **Restricted Air Hose** (naturally, water in the air will be pulled into the compressor tank and pushed through the air hose over time. This water will collect and freeze inside the air hose and slowly start to restrict air flow to the snow gun. Typically, a 25' air hose will have 3-4 hours of good use before this becomes an issue. Longer air hoses will freeze even quicker)

SOLUTION: 1.) Use a short 10' air hose to eliminate this issue. Shorter air hoses will significantly reduce the likelihood of water freezing in the air line. A 10' air hose will have no issues for 12+ hours of use. 2.) Use a larger diameter air hose to increase the amount of time before clogging becomes an issue. 3.) Insulate your longer hose to prevent freezing/clogging. 4.) Install a desiccant air dryer on your compressor to eliminate any water from entering the tank and hose.

TROUBLESHOOTING HELP

MAKING ICE (or low-quality snow) CONTINUED

- **Wind / Heavy Natural Snow Fall** (Wind can blow water and snow back onto the snow gun, resulting in ice accumulating on the head and restricting the bottom nucleation nozzle spray plume. If the spray plume is unable to mix with top misting spray, ice will form instead of snow)

SOLUTION: Wait until it is NOT windy to make snow. If you choose to make snow in the wind, try pointing the snow gun spray with the wind, NOT against it. Another option would be to use heat tape on the head of the snow gun. If snow does fall back onto the snow gun, the heat tape will melt the snow and stop it from building up.

- **Incorrect Nozzle Selection** (The nozzles provided with each snow gun are designed to be matched to the flow rate of your pressure washer. This is done to regulate the water pressure in the snow gun so that, 1.) the correct water droplet size is created in the top misting spray, and 2.) the correct amount of water is supplied to the bottom nucleation nozzle for ice crystal formation. If the correct nozzles are not installed to match the water pressure, the water droplets will either be too big or too small, resulting in ice.

SOLUTION: Install the correct nozzles shown in the nozzle configuration chart. Double check the pressure gauge and make sure you have water pressure in the correct pressure range.

TROUBLESHOOTING HELP

MAKING ICE (or low-quality snow) CONTINUED

- **The Temperature/Humidity combination is too warm** (Sounds simple, right? Making snow on the edge of “possible” snowmaking conditions is difficult. Many times, the temperature/humidity shown on most phone apps are not entirely accurate.

SOLUTION: Wait until temperatures drop to at least 28°F to make snow. Pay attention to the forecast and how cold it will get during the night. If the low is on the edge of snowmaking temperatures, it may be worth it wait for a colder night. If the low is predicted to be much colder, then you can be confident that temperatures will continue to drop, and snowmaking will be possible.

- **Equipment Malfunction/Tripped Breakers** (If your pressure washer(s) or air compressor malfunction, then you will likely make some ice. Tripping an electrical breaker is a likely cause of equipment malfunctions. If you overload one breaker and it trips, then your pressure washer(s) and/or air compressor will turn off, resulting in ice. In our experience of snowmaking, equipment very rarely quits working during operation. If your equipment is getting old, it will usually quit working after a power cycle, not during operation.

SOLUTION: Plug in your pressure washer(s) and air compressor on separate breakers in your home. Check the amp rating of your equipment. Typically, small electric pressure washers and air compressors are around 13-15 amps, and most homes will have 15- or 20-amp breakers. If you plug both items into outlets on the same breaker, it will likely overload the breaker and trip. We also recommend periodically checking your equipment to make sure it is running smoothly.

TROUBLESHOOTING HELP

MAKING ICE (or low-quality snow) CONTINUED

- **No water is exiting the Nucleation Nozzle** (The most common reason that no water would exit the nucleation nozzle is because the nozzle in the snow gun is frozen. If the air hose was connected before the water AND pressure washer were turned on, freezing can occur. This can also occur if water was left in the snow gun and froze during setup)

SOLUTION: Take the snow gun indoors to thaw. Run the snow gun under warm water if necessary. If freezing occurs, it is likely in the small fitting directly below the snow gun head inside of the aluminum housing. Run warm water over the bottom of the snow gun head near the top of the housing.

Make sure no water is left in the snow gun after use. Use the HP Blow Out Tool to remove all water from the snow gun after each session. Store indoors in a warm, dry location. Bring the snow gun outside only when you are ready to turn the water on to minimize the snow guns exposure to cold temperatures.

Snowmaking Weather Chart

Outside Temperature (F°)	WET BULB TEMPERATURE									
	20%	30%	40%	50%	60%	70%	80%	90%	100%	
14°	9	10	11	11	12	12	13	13	14	IDEAL SNOWMAKING
15°	10	11	11	12	13	13	14	14	15	
16°	11	12	12	13	14	14	15	15	16	
17°	12	13	13	14	14	15	16	16	17	
18°	13	13	14	15	15	16	17	17	18	
19°	14	14	15	16	16	17	18	18	19	
20°	14	15	16	16	17	18	19	19	20	MARGINAL SNOWMAKING
21°	15	16	17	17	18	19	19	20	21	
22°	16	17	17	18	19	20	20	21	22	
23°	17	18	18	19	20	21	21	22	23	
24°	18	18	19	20	21	22	22	23	24	
25°	18	19	20	21	22	22	23	24	25	
26°	19	20	21	22	23	23	24	25	26	SNOWMAKING NOT POSSIBLE
27°	20	21	22	23	23	24	25	26	27	
28°	21	22	23	24	24	25	26	27	28	
29°	21	22	23	23	25	26	27	28	29	
30°	22	23	24	25	26	27	28	29	30	
31°	23	24	25	26	27	28	29	30	31	
32°	24	25	26	27	28	29	30	31	32	
33°	24	26	27	28	29	30	31	32	33	
34°	25	26	27	29	30	31	32	33	34	
35°	26	27	28	29	31	32	33	34	35	
36°	27	28	29	30	31	33	34	35	36	
37°	27	29	30	31	32	34	35	36	37	
38°	28	29	31	32	33	35	36	37	38	



Snowmaking is possible when the temperature and humidity (Wet Bulb Temperature) are in the correct range.

Snow created in the Ideal Snowmaking Section will be higher quality and “lighter” (powder snow).

Snow created in the Marginal Snowmaking Section will be a little “heavier” (packing snow).

EXPERT ADVICE: Wait until the outside temperature reaches 28°F or lower to turn on your system. Trying to make snow on the edge of marginal conditions can yield poor results.

Quick Guide

Setup

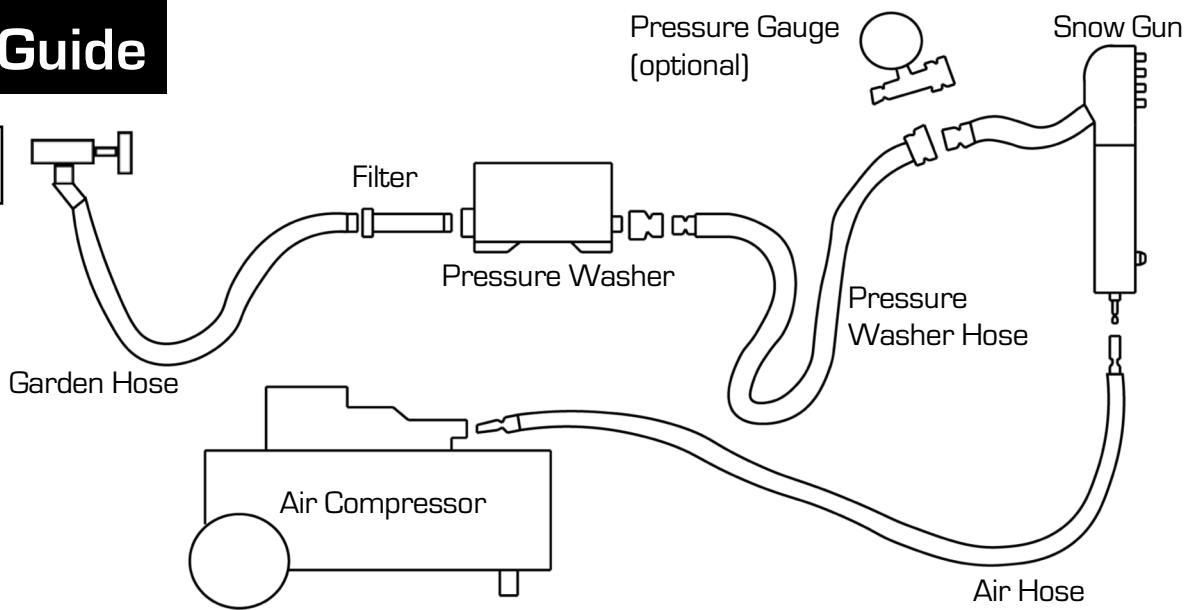

- Turn on water
- Turn on pressure washer(s)
- Connect/turn on air compressor

Water Pressure: 400-800 PSI
Air Pressure: 70-125 PSI

Take Down

- Unplug air hose
- Turn off pressure washer(s)
- Turn off water
- Blow out water line/individual components
- Store equipment in a warm, dry location

EXPERT TIPS

- Use a 10' air hose, air dryer, or insulated air hose
- Wait for 28°F or colder to start the system
- Blow out each item separately after each session
- Store equipment in a warm, dry location